



HILO™

LED Flood Light



Beyond LED's HILO Flood lights are the best solutions to replace HID lamps. Our HILO Flood light comes with DOB (driver on board) technology, offers high lumens per watt for maximum power savings and rebates from power companies. HILO Flood Light comes with Knuckle mount and optional U-Bracket. Superior performance & robust design makes this product suitable for any general-purpose floodlighting application such as landscape, signage and accent lighting in heavy commercial & residential applications.

Product Features

- Up to 110 Lumens Per Watt
- Input Voltage 120Vac
- Beam Angle 115° Degree
- DOB (driver on board) technology
- Integral LED driver (non-isolated), eliminates the need for an external driver or ballast
- Beam Angle 115° Degree
- High Quality & Efficacy SMD2835 Chips
- IP65 Rated
- UL & DLC listed
- 3 Years warranty

HILO™

LED Flood Light



SKU #	Model #	Watt	Lumens	CCT	Housing	Dimming	IP	Input Voltage	Certifications
155664	BLT-FLD01-50WJCGA2-BRAM50	50W	5500Lm	5000K	Bronze	N/A	IP65	120Vac	UL
156192	BLT-FLD01-80WJCGA2-BRAM50	80W	8800Lm	5000K	Bronze	N/A	IP65	120Vac	UL
155665	BLT-FLD01-100WJCGA2-BRAM50	100W	11000Lm	5000K	Bronze	N/A	IP65	120Vac	UL
155666	BLT-FLD01-150WJCGA3-BRAM50	150W	19950Lm	5000K	Bronze	0-10V	IP65	120-277Vac	UL & DLC

SKU: 155664 Specifications

Parameter	Description	Value
General Performance	Wattage	50W
	Lumen	Up to 5500LM
	Lumen Efficacy	Up to 110LM/W
	Color Temperature	5000K
	CRI (Ra)	>80
	Beam Angle	115° Degree
	Input Voltage	120Vac
	Frequency	50/60Hz
Electrical	Optional Accessory	N/A
	PF (Tolerance: -3%)	AC120V≥0.9
	THD (Tolerance : +5%)	≤20%
	Driver Model	N/A
	Dimming	N/A
Physical	Driver Surge protection	L/N-PE: 2kV, L-N: 2kV
	Operating Temperature	-30°C to 45°C
	Storage Temperature	-40°C to 80°C
	Operating Humidity	20% - 90% RH
	Storage Humidity	20% - 95% RH
	LED Brand	Bridgelux
	LED Type	SMD2835
LED QTY	75 PCS	
Qualification	Housing	Die-cast aluminum
	Housing Color	Bronze
	IP Rating	IP65
	Warranty	3 Years warranty

LED FLOOD LIGHT



HILO™

LED Flood Light

SKU: 156192

Specifications

Parameter	Description	Value
General Performance	Wattage	80W
	Lumen	Up to 8800LM
	Lumen Efficacy	Up to 110LM/W
	Color Temperature	5000K
	CRI (Ra)	>80
	Beam Angle	115° Degree
	Input Voltage	120Vac
Electrical	Frequency	50/60Hz
	Optional Accessory	N/A
	PF (Tolerance: -3%)	AC120V≥0.9
	THD (Tolerance : +5%)	≤20%
	Driver Model	N/A
Physical	Dimming	N/A
	Driver Surge protection	L/N-PE: 2kV, L-N: 2kV
	Operating Temperature	-30°C to 45°C
	Storage Temperature	-40°C to 80°C
	Operating Humidity	20% - 90% RH
	Storage Humidity	20% - 95% RH
	LED Brand	Bridgelux
	LED Type	SMD2835
LED QTY	135 PCS	
Qualification	Housing	Die-cast aluminum
	Housing Color	Bronze
	IP Rating	IP65
	Warranty	3 Years warranty

HILO™

LED Flood Light



SKU: 155665

Specifications

Parameter	Description	Value
General Performance	Wattage	100W
	Lumen	Up to 11000LM
	Lumen Efficacy	Up to 110LM/W
	Color Temperature	5000K
	CRI (Ra)	>80
	Beam Angle	115° Degree
	Input Voltage	120Vac
	Frequency	50/60Hz
Electrical	Optional Accessory	N/A
	PF (Tolerance: -3%)	≥0.9
	THD (Tolerance : +5%)	≤20%
	Driver Model	N/A
	Dimming	N/A
Physical	Driver Surge protection	L/N-PE: 2kV, L-N: 2kV
	Operating Temperature	-30°C to 45°C
	Storage Temperature	-40°C to 80°C
	Operating Humidity	20% - 90% RH
	Storage Humidity	20% - 95% RH
	LED Brand	Bridgelux
	LED Type	SMD2835
	LED QTY	135 PCS
Qualification	Housing	Die-cast aluminum
	Housing Color	Bronze
	IP Rating	IP65
	Warranty	3 Years warranty

LED FLOOD LIGHT



HILO™

LED Flood Light

SKU: 155666

Specifications

Parameter	Description	Value
General Performance	Wattage	150W
	Lumen	Up to 19950LM
	Lumen Efficacy	Up to 133LM/W
	Color Temperature	5000K
	CRI (Ra)	>80
	Beam Angle	120° Degree
	Input Voltage	120-277Vac
	Frequency	50/60Hz
Electrical	Optional Accessory	N/A
	PF (Tolerance: -3%)	≥0.9
	THD (Tolerance : +5%)	≤20%
	Driver Model	HBE Driver
	Dimming	0-10V
Physical	Driver Surge protection	L/N-PE: 6kV, L-N:6kV
	Operating Temperature	-30°C to 45°C
	Storage Temperature	-40°C to 80°C
	Operating Humidity	20% - 90% RH
	Storage Humidity	20% - 95% RH
	LED Brand	Bridgelux
	LED Type	SMD2835
LED QTY	208 PCS	
Qualification	Housing	Die-cast aluminum
	Housing Color	Bronze
	IP Rating	IP65
	Warranty	3 Years

HILO™

LED Flood Light



Correlated Color Temperature (CCT)

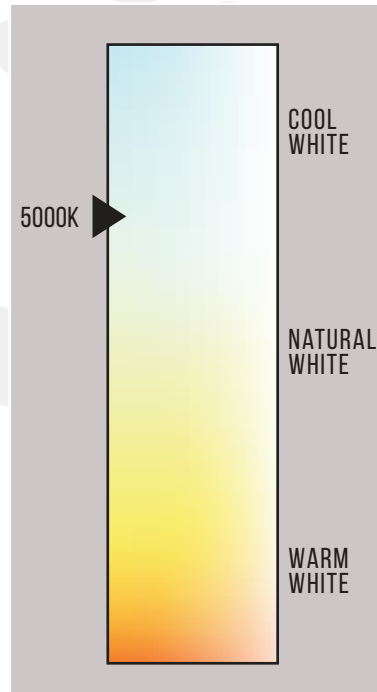

Dimensions

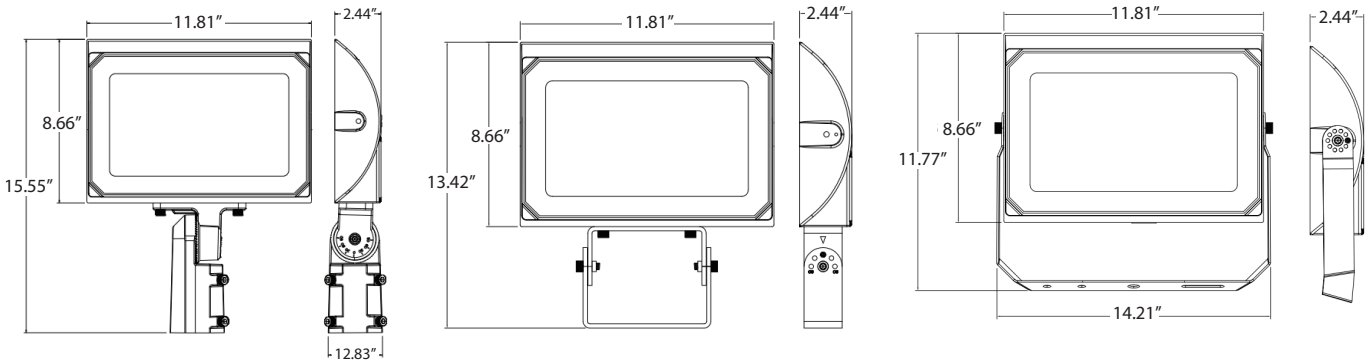



HILO™

LED Flood Light

Installation

Cautions:

1. Do not use the electric generator to test the LED lamp.
2. Please abide by related country, regional and local law and regulations when install this fixture.
3. Please turn off the power before installation or maintenance.
4. Proper grounding is required to ensure safety.

Notice:

1. To avoid possibility of electrical shock or fire, the installation personnel must have professional electric knowledge.
2. Please wear gloves to avoid injury before installation.
3. If any smoke or spark of the wire happened, please turn off the power immediately and notify relevant personnel.

Attention:

1. Please check if there is any damage during shipping. If so, please contact manufacturer timely.
2. Please read the installation instruction carefully to check whether all the accessories are available. After confirmation, install the fixture according to installation steps.

Instruction:

The installation of this LED light with different wattage is different. Please refer to the installation instruction correspondingly.

Wiring Diagram

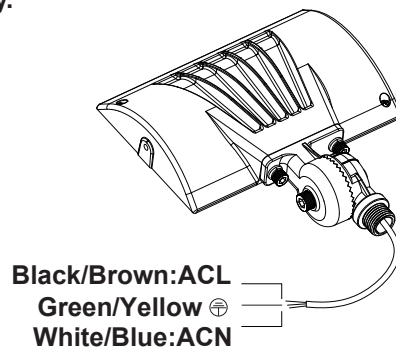

Installation 1: Installation with adjustable fitter

1.1 Adjustable fitter mounting (b=AM suitable for all power of this series)

- Step 1: Take the lamp out of package;
Step 2: Pass the wires through hardware and fix it with screws; (figure 1.1)
Step 3: Pass the wires through from the other bracket and rubber, fix it with screws.
(Watch out not to scratch the wire); (figure 1.2)
Step 4: finished. (figure 1.3)

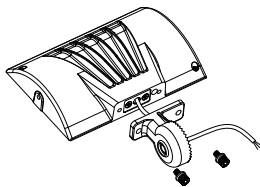

figure 1.1

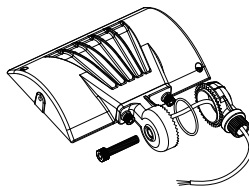

figure 1.2

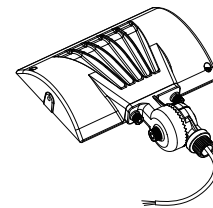

figure 1.3

HILO™

LED Flood Light



Installation

1.2 Installation of LED lamp with adjustable fitter (b=AM suitable for all power of this series)

Step 1: Take the lamp out of package.

Step 2: Connect the wires properly according to the right wiring requirements (pay attention to positive wire, negative wire, and ground wire) and then put the wires into lamp pole; (figure 1.4)

Step 3: Loosen the screws, adjust the lamp angles as per actual demands and then tighten the screws.

Tips: Angles of the lamp is adjustable
(pass the bracket through mounting surface, fix it with screws, then connect the wires as Hexagon socket screws)

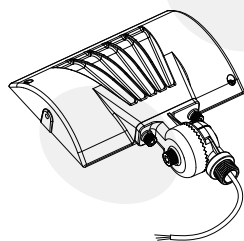

Bracket

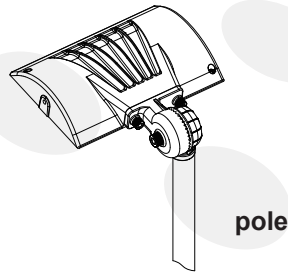

pole

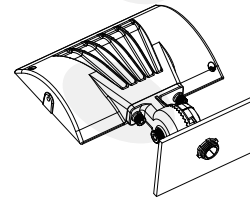

Black/Brown:ACL
Green/Yellow ⊕
White/Blue:ACN

figure 1.4

figure 1.5

Installation 2: Installation with Yoke Mount

2.1 Yoke Mount installation (b=YM suitable for all power of this series)

Step 1: Take the lamp out of package.

Step 2: Pass the wires through hole of bracket. (figure 2.1)

Step 3: Fix the lamp and bracket together with screws; (Watch out not to scratch the wire) (figure 2.2)

Step 4: Tighten the other bracket with screws. (figure 2.3)

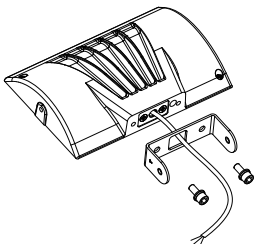

figure 2.1

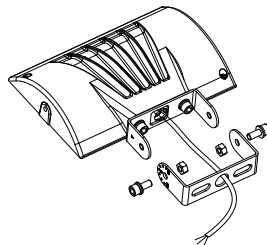

figure 2.2

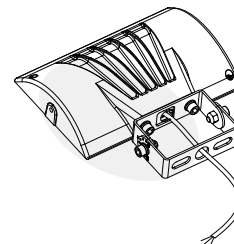

figure 2.3

2.2 Installation of LED lamp with Yoke Mount (b=YM suitable for all power of this series)

Step 1: Take the lamp out of package;

Step 2: Connect the wires properly according to the right wiring requirements (pay attention to positive wire, negative wire, and ground wire), and then put the wires into lamp pole; (figure 2.4)

Step 3: Loosen the screws, adjust the lamp angles as per actual demands and then tighten the screws; (figure 2.5)

Tips: Angles of the lamp is adjustable



HILO™ LED Flood Light

Installation

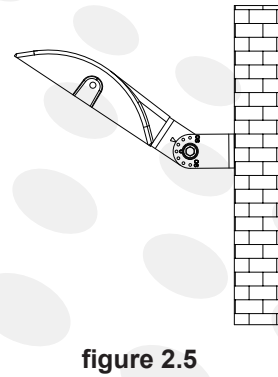
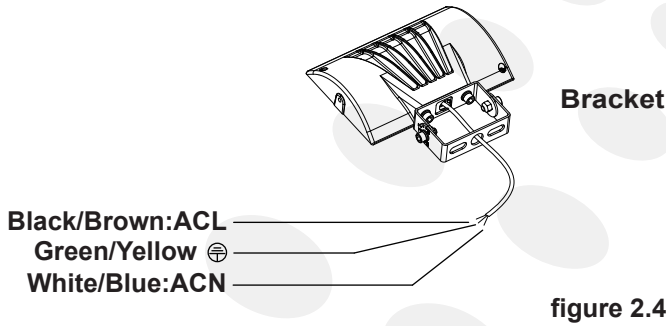

Installation 3: Installation with Flood Mount

3.1 Flood Mount Installation (b=FM suitable for all power of this series)

Step 1: Take the lamp out of package. (figure 3.1)

Step 2: Tighten the brackets and screws. (figure 3.2)

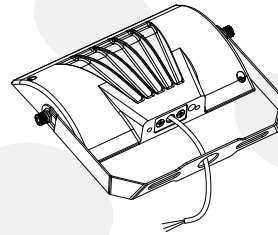
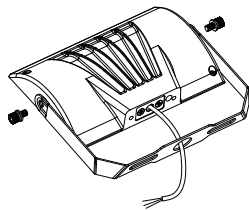

3.2 Installation of LED lamp with flood mount (b=FM suitable for all power of this series)

Step 1: Take the lamp out of package.

Step 2: Connect the wires properly according to the right wiring requirements (pay attention to positive wire, negative wire and ground wire), and then put the wires into lamp pole. (figure 3.3)

Step 3: Loosen the screws, adjust the lamp angles as per actual demands and then tighten the screws. (figure 3.4)

Tips: Angles of the lamp is adjustable.

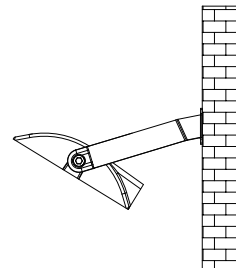
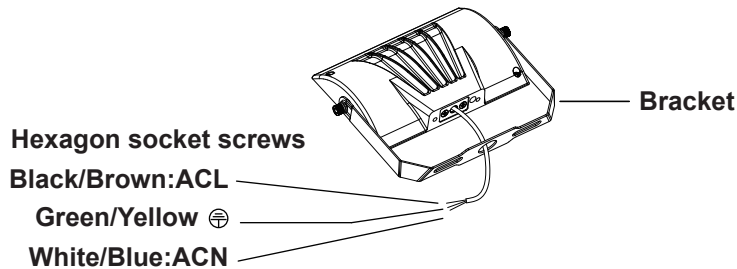

HILO™

LED Flood Light



Installation

Warning/Avertissement

MIN 75 °C SUPPLY CONDUCTORS.

THIS PRODUCT MUST BE INSTALLED IN ACCORDANCE WITH THE APPLICABLE INSTALLATION CODE BY A PERSON FAMILIAR WITH THE CONSTRUCTION AND OPERATION OF THE PRODUCT AND THE HAZARDS INVOLVED

LES FILS D'ALIMENTATION 75 °C MIN.

CCE PRODUIT DOIT ÊTRE INSTALLÉ SELON LE CODE D'INSTALLATION PERTINENT, PAR UNE PERSONNE QUI CONNAÎT BIEN LE PRODUIT ET SON FONCTIONNEMENT AINSI QUE LES RISQUES INHÉRENTS

Packaging

SKU	Type	Carton Size	Qty	Net Weight/Ctr.	Gross Weight/Ctr.
155664	Outer Box	23.54 x 11 x 10.39	10 Pcs/Box		
155664	Inner Box	9.64 x 2.24 x 10.35	1 Pcs/Box		
156192	Outer Box	18.89 x 11.88 x 11.57	8 Pcs/Box		
156192	Inner Box	10.82 x 2.24 x 11.33	1 Pcs/Box		
155665	Outer Box	15.55 x 13 x 15	4 Pcs/Box		
155665	Inner Box	14.17 x 3.03 x 15.07	1 Pcs/Box		
155666	Outer Box	15.55 x 13 x 15	4 Pcs/Box		
155666	Inner Box	14.17 x 3.03 x 15.07	1 Pcs/Box		



HILO™

LED Flood Light

Application Image



Warranty

3 Year Warranty